

FOREST[®]

DRAPERY HARDWARE



DS[®]
Design System

Product information

- Elegant and aesthetically pleasing hand drawn system for all types of medium weight draperies.
- Quick installation with "Smart Klick" brackets for wall and ceiling applications.
- Bendable; it can be curved for outside bends only using a 10 cm (4") radius or continuous curved.
- Hidden brackets through elegant shape of the track.
- Same brackets as used with KS system.
- Heavy duty clickable carriers - UV protected - for smooth and easy traversing. Offset shape for straight hanging pleats.
- Can also be used for ripplefold and accordiafold drapery systems.
- Maximum fabric weight: 8 kg per meter (6 LBS per ft.).
- Colours available: white, silver and black.
- Special colours: available on request.
- Available lengths: 4 meter (13'1"), 5 meter (16'4"), 6 meter (19'8"), 7 meter (23"). Silver and black only in 5 meter length.
- Track finish: chromated powder coating with a factory applied patented dry lubricant.
- Limited lifetime warranty.

Applications

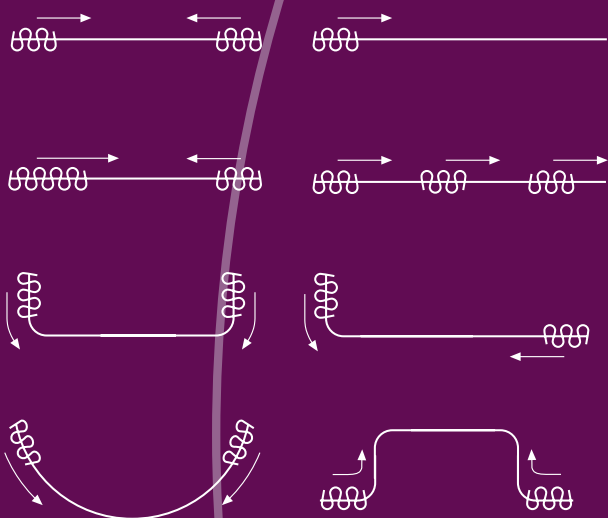

For use in

Hotels - offices - schools - healthcare - residences - boats - campers - planes or at any location where an elegant efficient hand drawn system is required.

Profile

- Shown actual size 1:1.
- Aluminum Extrusion.
- Weight: 170 grams per meter (1.83 ounce per ft.).
- Dimensions: 11 mm x 24 mm (0,4" x 0,9").

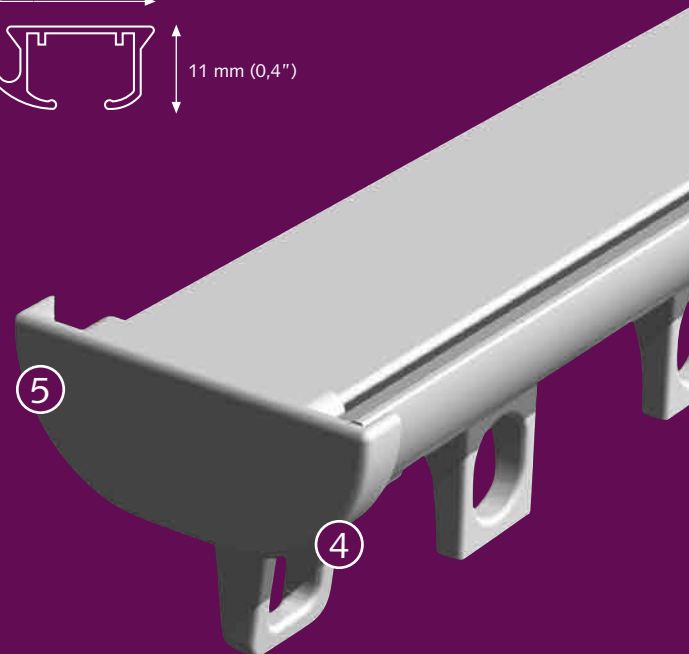
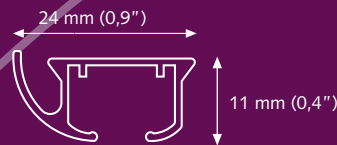

Bending/ curving

The track can be curved for outside bends by using a 10 cm (4") radius. Continuous curving is available by special order from factory only.



- ① DS track
- ② Carrier
- ③ Stop carrier
- ④ End stop
- ⑤ End cap

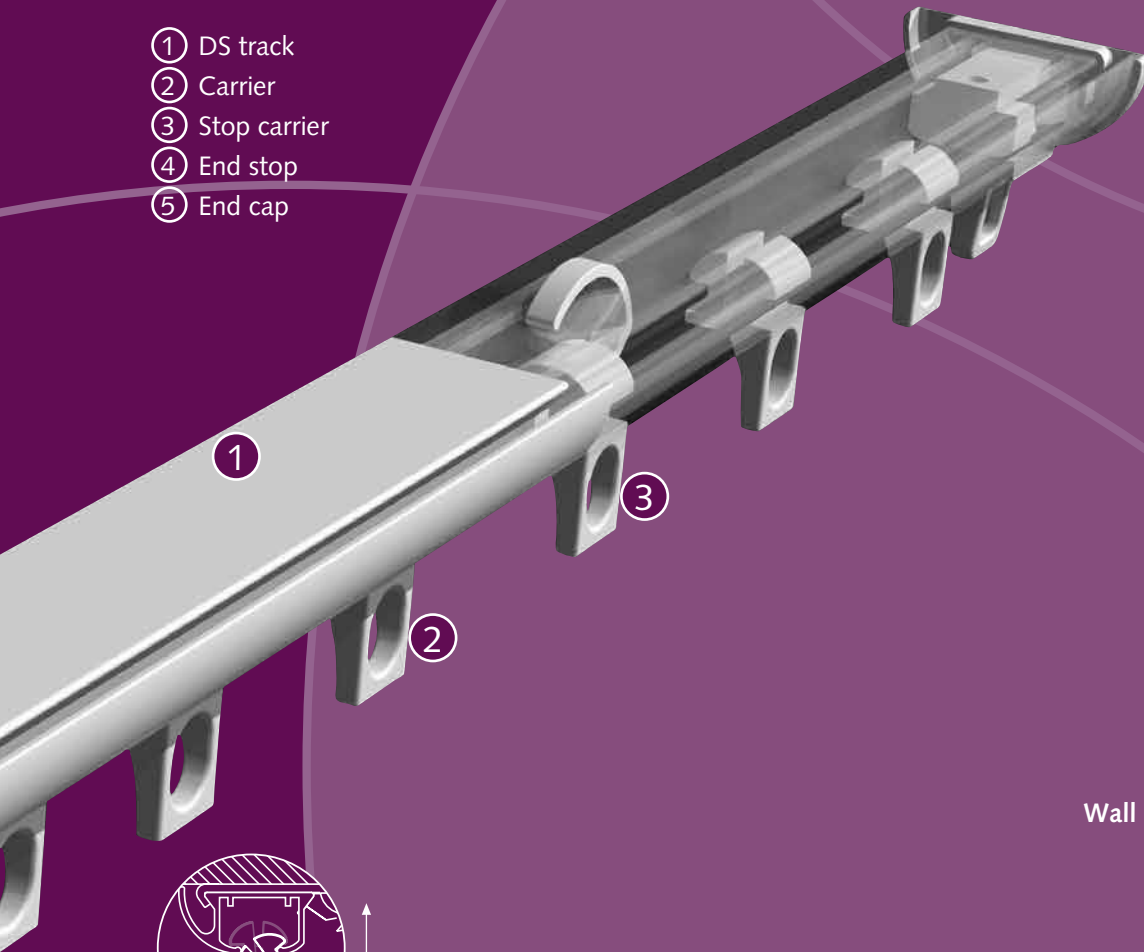

Mounting Brackets

Ceiling Bracket



4,2 cm (1,7")

Wall bracket

3,5 cm (1,4")
6 cm (2,4")

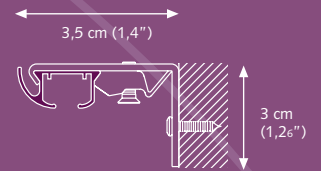

Wall bracket aluminium single

7,5 cm (3")
10 cm (4")
15 cm (6")

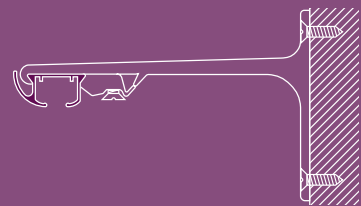

Wall bracket aluminium double

15 cm (6")
20 cm (8")

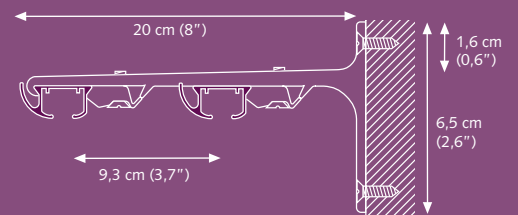

22 mm (0,9")

clickable carrier



Easy installation
click - position - tighten

- Other brackets are available. Brackets need to be placed every 60 cm (24").

Colours available from stock:

Complete the art.nr. with the indicated colour-code

01 White 03 Silver 06 Black

Other colours can be delivered on request.

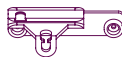
**Carrier Overlap Right**

The Plastic Master is reversible. There are also snaps on the back of the Master. Colours: 00, 01, 03, 06.

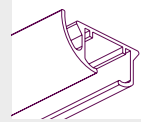
25 pcs/box
48152..010**DS Track**

Aluminium extrusion, powder coated, lubricated. 4 m (13'1"), 5 m (16'4"), 6 m (19'8"), 7 m (23").

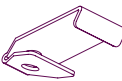
20010.. .00 cm
20/tube**Ceiling Bracket**

Slides onto the track, powder coated. Regular duty. Colours: 01, 03, 06.

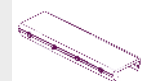
10180..000
100/box**KS/DS/CKS Track Joiner**1018401010
10/box**Ceiling Bracket with Slot**

Slides onto the track, powder coated. Regular duty. Colours: 01, 03, 06.

10181..000
100/box**Carrier**

"Klickable", offset, constructed of UV resistant plastic. 10 Carriers on a break-away strip. Can be clicked in after installation. Colours: 01, 03, 06.

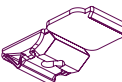
10100..000
500/box**Smart Klick Ceiling Bracket**

"Klicks" onto track, powder coated. Colours: 01, 03, 06. Inclusive Covercap

10182..000
100/box

1018201001

**Stop Carrier**

Prevents slide back, "klickable", constructed of UV resistant plastic. Colours: 01, 03, 06.

10102..000
250/box**Covercap for Smart Klick Ceiling Bracket**

Fits on Smart Klick Wall and Ceiling bracket. Colours: 01, 03, 06.

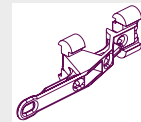
10182..001
100/box**Master Carrier/Reversible**

Reversible overlap carrier, "Klicks" into track, constructed of UV resistant plastic. For straight track only. Colour: 01.

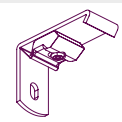
1010301000
25/box**Smart Klick Wall Bracket**

3,5 cm (1,4") and 6 cm (2,4"). "Klicks" onto track, powder coated. One screw attachment. For light weight use only. Colours: 01, 03, 06.

50/box

10202..035

10202..060

**Shirrtape Carrier**

Carrier and hook in one "klickable" unit, constructed of UV resistant plastic. For sew on drapery tape.

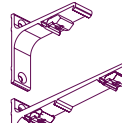
10104..000
500/box**Aluminium Wall bracket**

Smart klick, powder coated.

10203.. ...mm

7,5 cm single (3")	20/box
10 cm single (4")	20/box
15 cm double (6")	15/box
20 cm double (8")	15/box
25 cm triple (10")	10/box

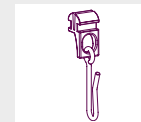
**Carrier with Metal Hook**

"Klickable", offset, with stainless steel hook, constructed of UV resistant plastic. For use with grommets.

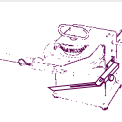
10105..000
100/box**Compact Bending House**

For DS

1050000000
1/each**Twist End Stop**

"Twists" into track, with metal plate, constructed of UV resistant plastic. Colours: 01, 03, 06.

10162..000
100/box**DS Bending Wheel All-in**

For DS incl. strips

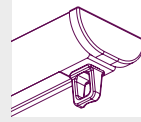
2050000000
1/each**Twist End Stop with Cap**

"Twists" into track, with metal plate and end cap, constructed of UV resistant plastic. Colours: 01, 03, 06.

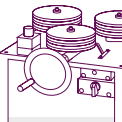
20163..000
100/box**Electric Powered Bender**

For creating continuous curves. Minimum radius 50 cm (20").

1060500000
1/box**Easyfold DS Endcap + screw**

To be screwed with an Easyfold carrier, made of UV-resistant plastic. Colours: 01, 03, 06.

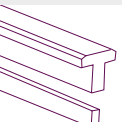
48161..000
100/box**Replacement Bending Strips**

For DS Compact Bending Tool. Length of strip: 60 cm (23"). For DS electric powered bender. Length of strip: 7 m (23').

2060100000
1/set2060300000
1/set**DS Endcap + Screw Short**

To be used for single drawn curtains. Colours: 01, 03, 06.

20060..000
100/box**Electric Powered Railcutter**

230 Volt EU

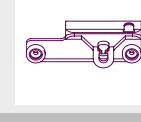
1061100000
1/each**Carrier Underlap Left**

The Plastic Master is reversible. There are also snaps on the back of the Master. Colours: 00, 01, 03, 06.

25 pcs/box
48151..010**Replacement Blade**

For electric powered railcutter.

1061200000
1/each**FOREST**
DRAPERY HARDWARE

Download Forest brochures